

# SAWTEQ

# S-500/S-510

**Performance tailored to your needs.**  
Our panel dividing saw

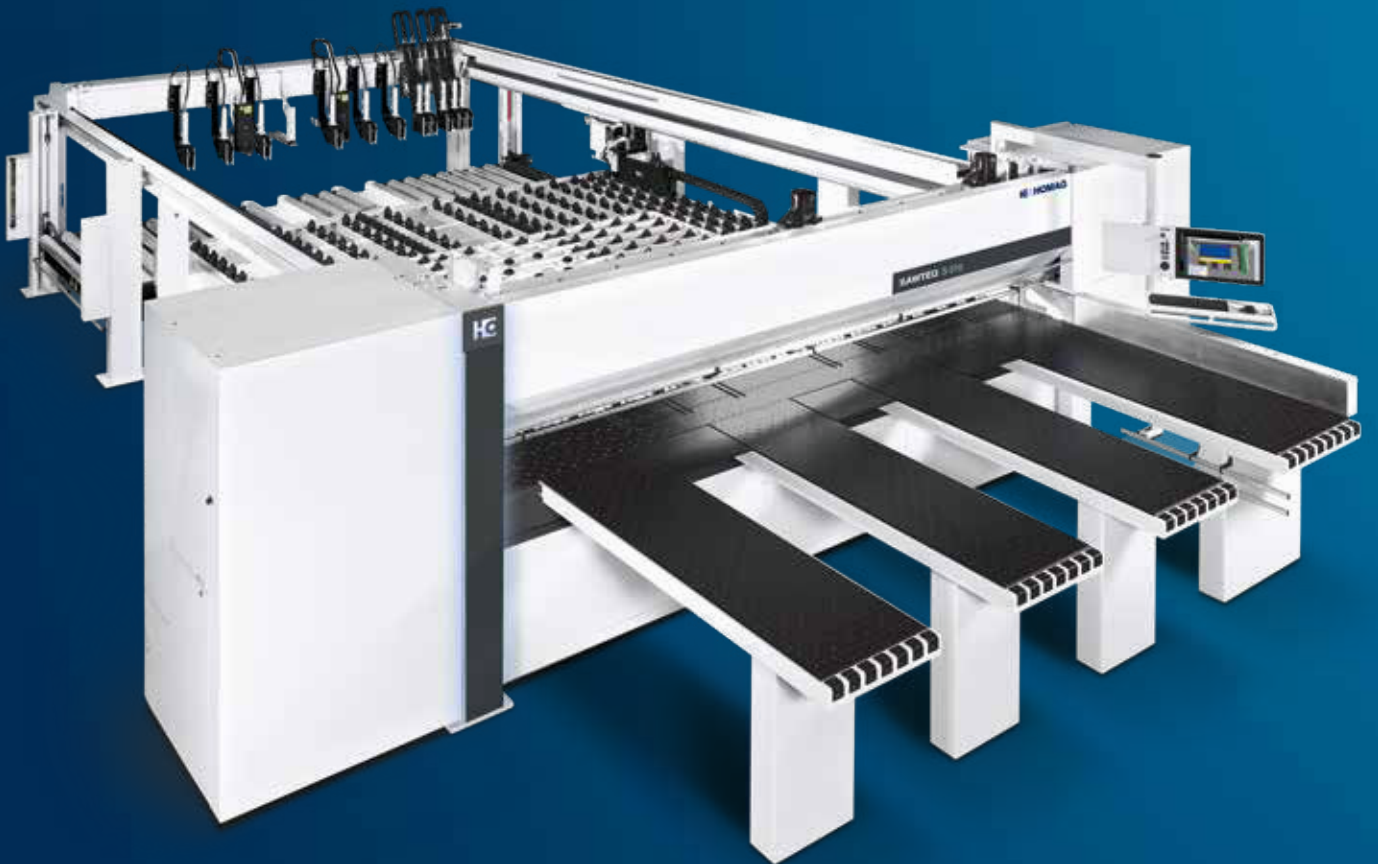



## SAWTEQ S-500 – Power and performance without compromise

The SAWTEQ S-500 and S-510 saws combine uncompromising technology and enormous material throughput with maximum availability. This is ensured by the fact that the saws are very easy to service and maintain. Overall, the SAWTEQ S-500 and S-510 are the result of a design that has been thought through to the finest detail and leading technology. In short: The saws stand for maximum performance and durability, combined with the greatest possible flexibility when it comes to saw configuration.

### YOUR SOLUTION

### CONTENTS

- 04 Software
- 12 SAWTEQ S-500
- 14 SAWTEQ S-510 with lifting table
- 17 Standard features
- 24 Optional features
- 40 Technical data
- 42 Service



## CADmatic 5 – intuitive to operate and open for digital networking

CADmatic 5 is the state-of-the-art, high-performance saw control system from HOMAG. It offers a wide range of functions and is easy to use thanks to the intuitive operating concept and clear management functions. What's more, CADmatic 5 is open for communication with other machines and software solutions.

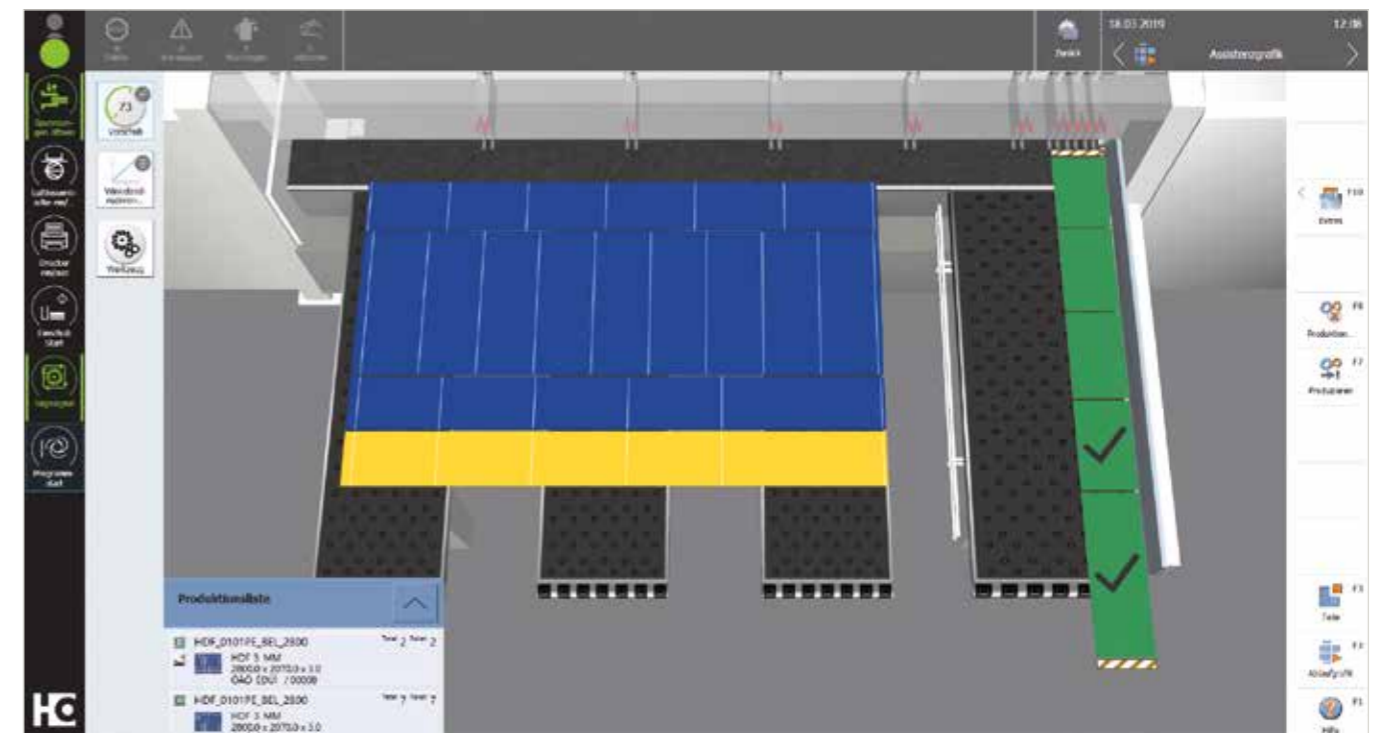

### CADmatic 5 – the change in perspective

The latest generation of the HOMAG saw control system has a 3D assistance graphic that clearly shows the machine operator all the steps in order. It is intuitive to operate, which shortens the training time and reduces errors to a minimum.

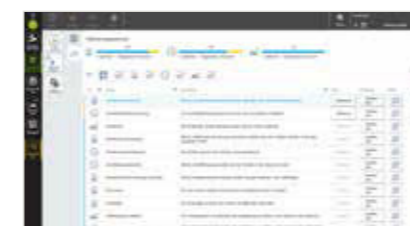

### NEW: quickTip – the assistant for optimal use of the machine functions

quickTip is a new assistance function integrated into the HOMAG saw control system for maximum quality, operating comfort and performance. It supports the machine operator by providing recommendations for optimal use of functions directly at the saw. The advantage is that the functions and parameters can be activated centrally at one single point in CADmatic – this simplifies work, ensures smooth processes and a uniformly high output.

### Highlights:

- Simple, intuitive and ergonomic machine operation thanks to the 3D assistance graphic including quickTip
- This results in efficient processes and a steady output
- Swiveling and tiltable 24" full-HD multi-touch display in widescreen format is easy to use by swiping, scrolling and zooming
- Uniform operating concept thanks to the powerTouch user interface
- All HOMAG saws with CADmatic 5 are automatically tapio-ready

**Find out more in the "CADmatic" brochure.**

## What's the difference? The software!

It efficiently integrates the machine into the production process. This results in seamless, intelligently networked processes from start to finish. In short: The right software unlocks new value-added potential. That is what makes it so important.

## Next generation of powerTouch: **powerTouch2**

Faster, clearer, easier to use: Enjoy the benefits of our further improved powerTouch user interface. We have optimized our standardized operating concept and further adapted it to our customers' needs. You can now control your HOMAG machines even faster and more intuitively. The new, modern design is clearly structured. The innovative touch operation is designed to enable you to achieve the desired result easily and conveniently.

With the new powerTouch generation, you can enter information on the machine more quickly. Time savings of up to 30% can be achieved compared to the previous version. This is possible thanks to new features, such as auto-complete, a pop-up keyboard that can be kept open and Windows-like functions, such as the selection of common actions directly via the start button.

Our successful powerTouch philosophy — **simple, standardized, ergonomic, evolutionary** — systematically enhanced

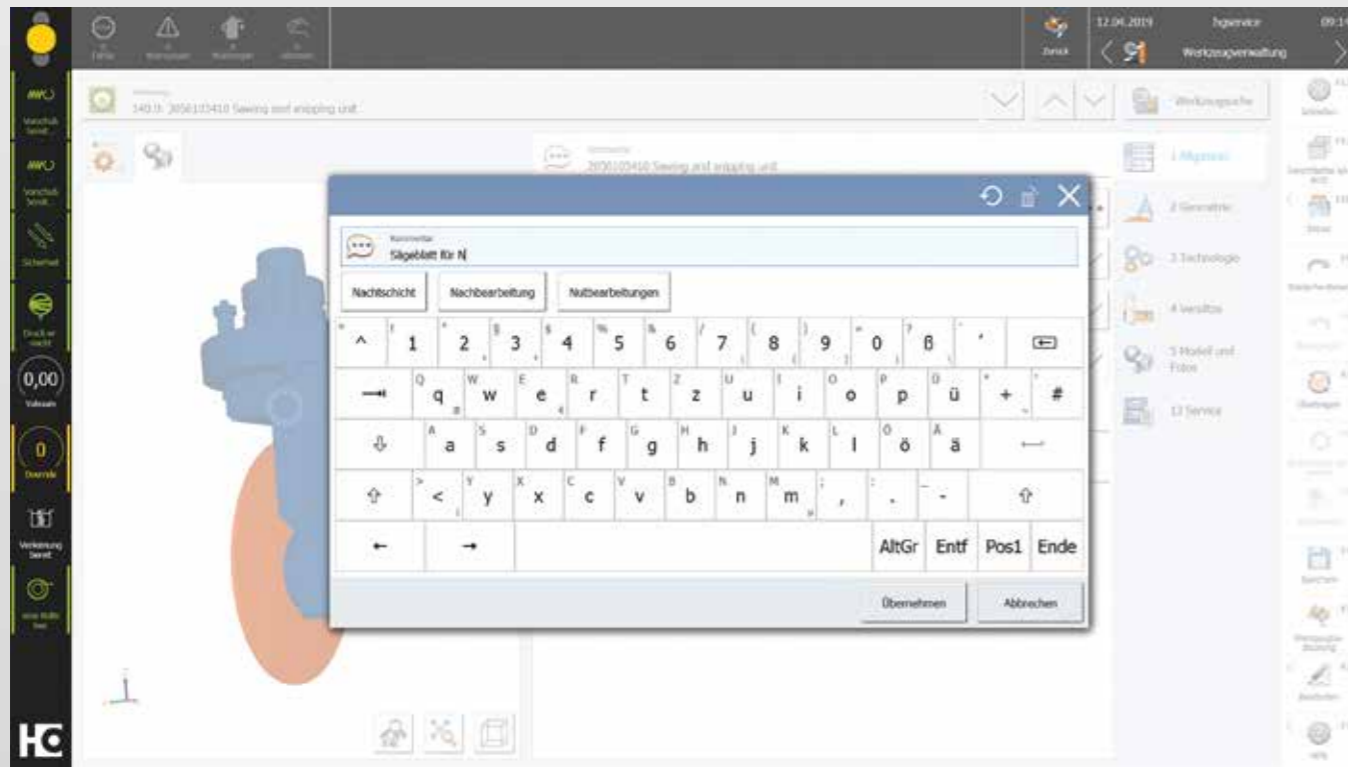

**1** The powerTouch2 screen is clearly laid out and logically structured. You can see all the key information at a glance, but you still have all the details.

**3** Functional pop-up keyboard that can be kept open, including auto-complete for faster input (when you enter the first few letters, frequently used applications are suggested and you can select them directly).

**2** We have also improved the traffic light dialog again. You can now directly influence the machine's production readiness by selecting actions via the traffic light icon.

**4** Enhanced "Start" menu that displays additional information (e.g. indicates how many messages there are, or has status bars that show how far the application has progressed) and allows actions to be called up directly (e.g. confirm actions without having to go to the application).

## Apps and digital assistants.

### Quick and easy support in the machine environment.

Some people still use pen and paper to create their cutting patterns. But they look at their smartphone if they want to know what the weather is like — instead of looking out of the window. We asked ourselves: Why not combine the best of both? Our apps and digital solutions make your everyday work easier: machines, material, tools, cutting patterns, components — you always have everything in your pocket or on your desk.



More information at [digital.homag.com](http://digital.homag.com)

#### WE HAVE DEVELOPED POWERFUL AND SMART SOLUTIONS FOR YOU:

- ✓ Always low investment
- ✓ Always up to date (no updates necessary)
- ✓ Always easy to use (no complex software)
- ✓ Always helpful

**HC** CREATE DATA

ORGANIZE **HC**

**HC** USE SUPPORT

OPTIMIZE CUTTING **HC**

**HC** MANAGE MATERIAL

OPTIMIZE NESTING **HC**

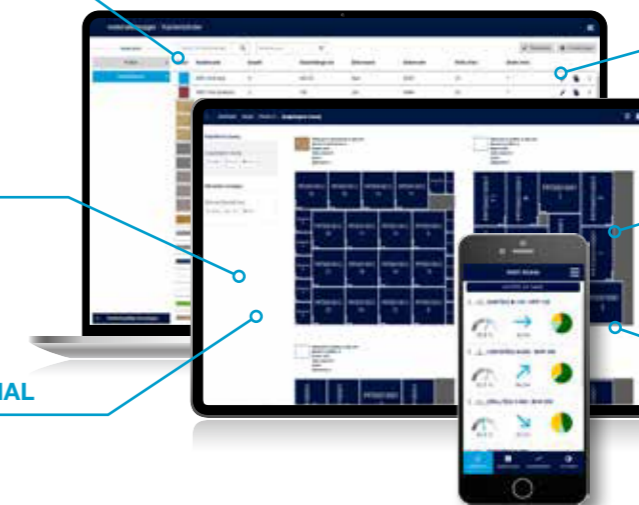

## Optional feature: Innovative operator guidance with IntelliGuide Classic

The innovative IntelliGuide operator assistance system is now available for the SAWTEQ S-500 and S-510. The Classic version features an LED strip at the cutting line which guides the operator by means of light signals.

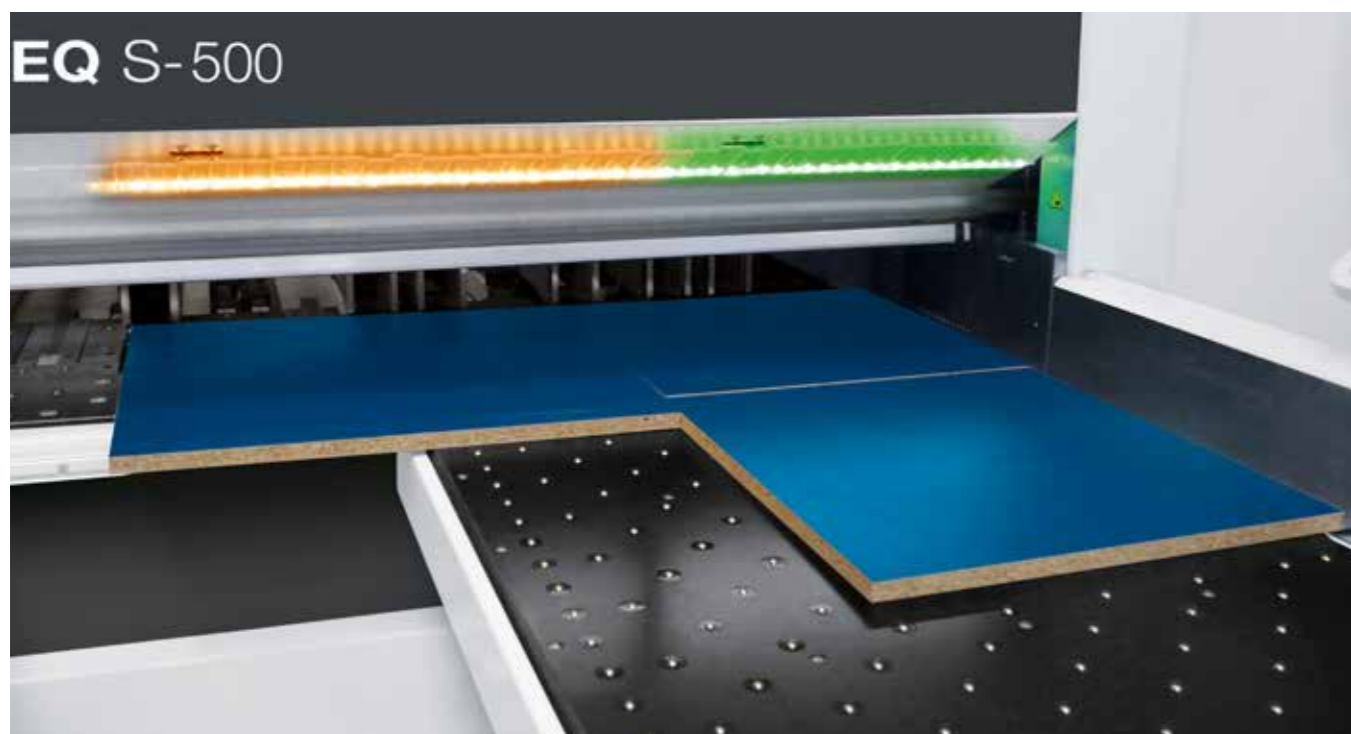

### IntelliGuide Classic at a glance

- Colored LED signals at the cutting line allow intuitive operation and a quicker, safer way of working
- Using the colored LED elements, machine operators can immediately see if a part has been fully processed, needs to be cut again or can be disposed of as a waste part
- On the basis of the LEDs that light up, the operator can determine whether the workpiece on the table meets the required specifications

Would you like more information? Find out more in the "IntelliGuide" brochure.

### Benefits of the IntelliGuide Classic

- Quick and easy processes: operator and saw work in tandem and do not slow each other down
- The machine is intuitive to operate thanks to colored LED signals: The operator rarely has to look at the monitor, allowing them to concentrate fully on processing the cutting pattern
- Smooth, ergonomic and safe processes for efficient working
- Easy to change operator at any time

## Optional feature: Increasing productivity with the appropriate cutting optimization software

Production time, material yield, parts handling and logistics: Efficient cutting with seamless processes requires intelligently optimized cutting patterns. For HOMAG saws, the appropriate optimization solution is available on demand – from large to small, as permanently installed software or directly from the tapio cloud. You have the choice because the SAWTEQ S-500 and S-510 are – like all HOMAG saws – tapio-ready.



### IntelliDivide – the easy way to achieve first-class optimization results

Simply upload the parts list. Done! The result? A choice of several alternatives for cutting patterns and entire runs. That's how easy IntelliDivide makes it.

In detail: The cloud-based optimization software IntelliDivide utilizes significantly higher computing capacities than are available for locally installed optimization software and can therefore swiftly provide the user with several alternative optimization results.

This means that with IntelliDivide the operator can choose from a variety of options, including results based purely on reducing waste, on the shortest machine time or on the simplest handling, perfectly adapted to the relevant requirements.

Applications are varied and are geared toward both woodworking shops and industry.



### Cut Rite cutting optimization software

Efficiency through planning: This short phrase sums up the key benefits of the Cut Rite software. With this world-leading software solution, you can optimize waste and systematically lower the overall costs for cutting.

#### Highlights

- Seamless, precise and highly efficient processes ensure optimized project control
- Efficient cutting processes which can be individually adapted to your production processes by means of parameter settings
- Full cost control within the cutting process: Material costs and processing time are calculated automatically when the quotation is prepared
- Faster calculations by using all the processors in the PC
- Simple handling: Clearly structured and easy to operate, with graphical display of information

Find out more in the "Cut Rite" brochure.

# Destacking concept: for zero errors – even with mixed stacks

The destacking concept guides the operator from depositing the first part to forming the perfect stacked pallet. This has been achieved by combining software and hardware in an overall concept. The software shows machine operators when and where they should stack each particular part. You select the appropriate hardware components according to your requirements. Altogether, this adds up to improved efficiency and ergonomics for all work steps. Times and routes that do not add value are systematically reduced.

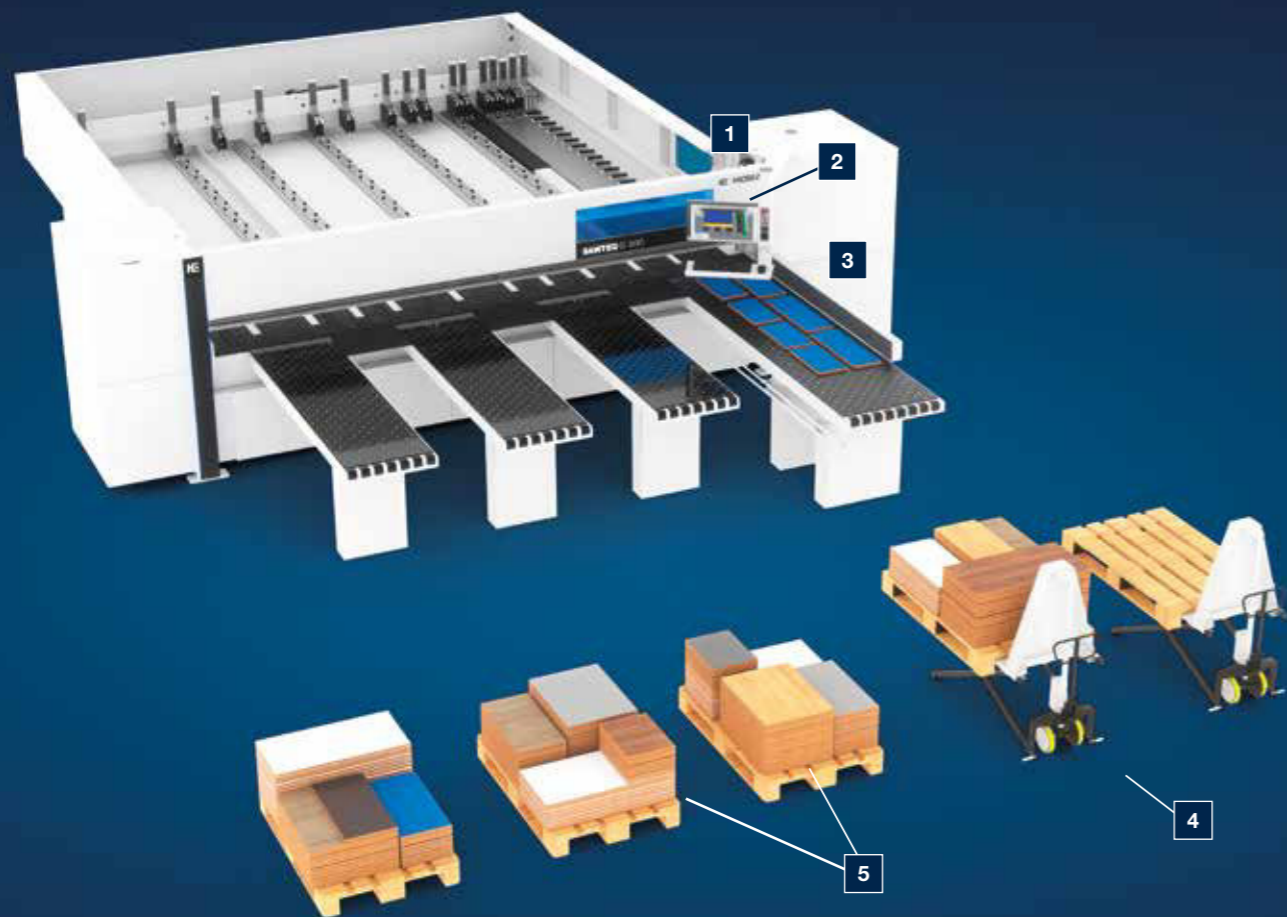

- 1** Destacking software as add-on module for CADmatic 5
- 2** Label printing with destacking details – using the manual label printer or the automatic label printer near the pressure beam (page 38)

- 3** Chopping edge
- 4** Scissor lift pallet truck "HuGo"
- 5** Intelligent stack formation

**MORE AT HOMAG.COM**



Material in motion



### CADmatic destacking module

Which part belongs where? The CADmatic destacking module answers this question by means of an integrated destacking graphic. This optional feature is available as part of the Classic and Advanced versions. In both versions, the single parts are color-coded in the cutting pattern and also in the assistance graphic. This means operators can see on the monitor exactly when they must place a particular part on a particular pallet.

Additional advantages with the Advanced destacking module: Operators are not only shown which part should be destacked onto which pallet, they also see exactly where a part is to be placed on the pallet.

This ensures intelligent, stable stack formation. Furthermore, the Advanced destacking module allows the program sequence and the destacking strategy to be controlled more delicately and appropriately. You can specify, for example, whether the stack formation is optimized for subsequent processing steps on the basis of the order or the material. These priorities can be combined with one another and weighted according to the primary objective.

This results in clear, highly efficient operator guidance with less walking between the saw and the destacking location, optimized pallet utilization and process-optimized, stable stack formation.



### Parts buffer with swiveling label printer

The parts buffer with swiveling label printer ensures efficient processes and ergonomic handling.

- It indicates to the operator by LED display whether a part should be temporarily stored. This is particularly useful for forming stable stacks or to avoid slowing down the saw, for example.
- The swiveling label printer is located in a convenient position for the operator and dispenses the right label for each part at the right time.



### Scissor lift pallet truck "HuGo"

The scissor lift pallet truck "HuGo" is equipped with automatic height control and facilitates ergonomic and intelligent destacking processes. A light barrier controls the automatic raising and lowering of the pallet truck, also allowing you to remove all the parts from the pallet at an ideal processing height — at an edge banding machine, for example.

**MORE AT HOMAG.COM**



Pallet truck "HuGo"

### Benefits

- The machine operator knows at all times which part is to be destacked and where. This reduces, among other things, distances to be covered and the time required
- Intelligent stack formation according to individual specifications
- Saves space, as demonstrably fewer pallets are required

## SAWTEQ S-500

The SAWTEQ S-500 features convincing innovative technologies and a uniquely solid design.

### The highlights

- Cutting lengths up to 6500 mm
- Equipped with high-end technologies



## SAWTEQ S-510 with lifting table

This saw improves ergonomics by providing the option of automatic feeding via the robust lifting table. It speeds up the production process even further.

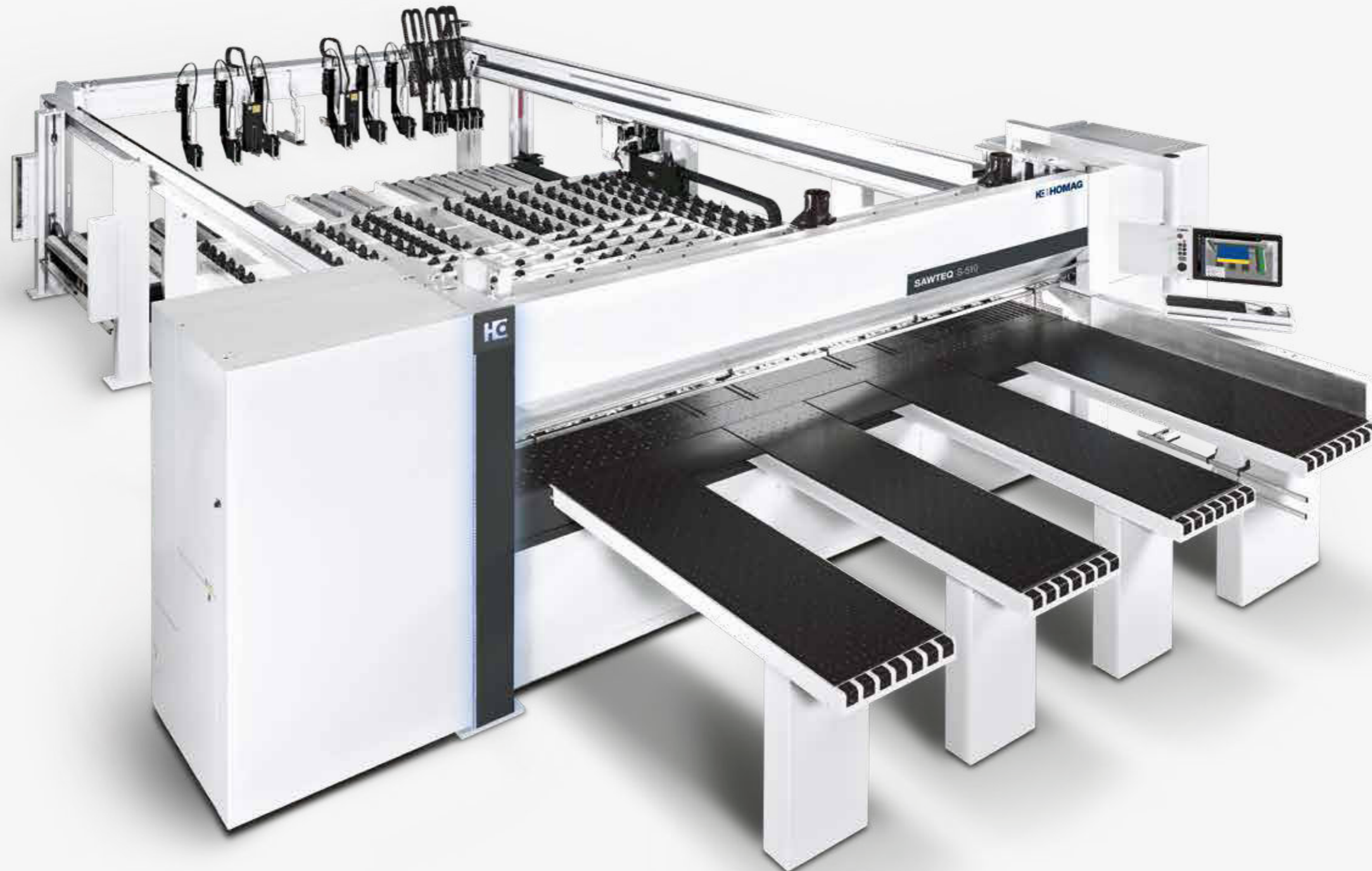

### The highlights

- Short production cycles due to automatic feeding
- Extremely rugged and designed for maximum operational demands
- Cutting lengths up to 6500 mm



## ecoPlus – because efficiency starts with the use of resources

Energy, time, material and personnel are all precious resources. Conserving them increases productivity and saves costs. HOMAG ecoPlus technologies help you to achieve this aim, providing countless innovations that save energy and reduce your operating costs. What's more, ecoPlus reduces CO<sub>2</sub> emissions and protects the environment. A worthwhile investment twice over.

### ECOPLUS TECHNOLOGIES FOR MAXIMUM ENERGY SAVINGS

- The standby button, a standard feature, puts the saw in an energy-saving standby mode at the touch of a button
- SAWTEQ S-500/S-510 with IE3 motors
- Variable speed control using a modern bypass circuit for all models with frequency-controlled main saw motor
- The geometry of the saw carriage enables highly efficient extraction
- All models are equipped with an energy monitor for monitoring consumption
- Less energy required thanks to optimized suction device



- Thin-cutting saw blades can be used on request, ensuring reduced waste and providing other benefits
- Many innovations for improved ergonomics and smooth production processes

### Standard features

Even in the standard version, the SAWTEQ S-500/S-510 offers the full range of standard features and can be put to flexible use, either as standalone machine, interlinked with other machines or as part of a production line, depending on the production concept. This makes the SAWTEQ S-500/S-510 the ideal solution for woodworking shops and industry in many applications.

## Optimum performance is the result of numerous high-tech solutions

Speed, quality and precision during the cutting process can only be achieved if panel materials are moved quickly, gently and with a high level of accuracy. This is ensured by numerous technologies that interact smoothly with one another – from the program fence and pressure beam to the clamps and patented side pressure device.



### Solid pressure beam for first-class cutting quality

- Large-area pressure zone directly at the cutting line reduces material vibrations to a minimum
- Impressive dust extraction thanks to the special geometry in the pressure beam – dust is extracted without causing any turbulence and via the shortest route, even through the right-angled fence
- Micro-joint technology: Slots for optional clamps are securely sealed, but can be opened easily if required

- Clip-in brushes (patented) attached to the inside of the clamp slots seal the pressure beam and prevent dust from escaping. The brushes can be changed quickly and easily thanks to clip system
- CADmatic controls the contact pressure of the pressure beam for the specific workpiece – always over the entire cutting length, for minimum torsion
- Toothed rack and pinion ensure the necessary parallel adjustment
- Linear guide on both sides for precise cuts, even in books

### Program fence for precision and dimensional accuracy

- Resistant to torsion and bending
- Electronically controlled
- Precise linear guidance on H-girder
- Electromagnetic measuring system guarantees positioning accuracy of  $\pm 0.1$  mm/m
- Measuring system involves no wear and no maintenance



### Patented: Central side pressure device

- Integrated directly in the saw carriage, which shortens cycle times by up to 25% in comparison with conventional systems
- Infinitely variable adjustment of contact pressure – depending on panel thickness. This allows even thin panels, laminates or sensitive materials to be processed perfectly. Another key feature here is the book-height-dependent control of the contact pressure: The higher the book, the greater the pressure

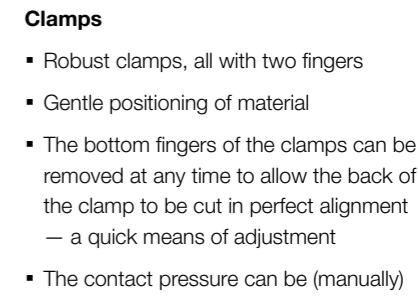
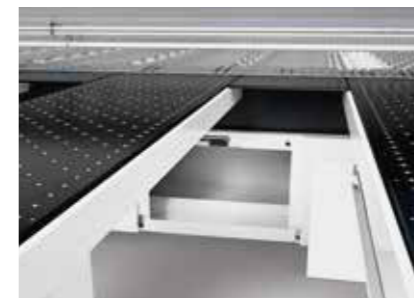

### Clamps

- Robust clamps, all with two fingers
- Gentle positioning of material
- The bottom fingers of the clamps can be removed at any time to allow the back of the clamp to be cut in perfect alignment – a quick means of adjustment
- The contact pressure can be (manually) adjusted individually and irrespective of the book height for the material being processed
- The top fingers of the clamps do not exert any leverage; instead, they are lowered horizontally and their entire contact surface rests on the material. This increases the working depth and ensures material is held firmly
- Program-activated clamps prevent damage to panel edges (optional)
- Designed for continuous, multi-shift operation

### Handy cleaning flaps

Quick and convenient: The area under the saw carriage is easily accessible via flaps, allowing easy removal or vacuuming of cutting waste.

### MORE AT HOMAG.COM



Central side pressure device



Cleaning flaps

## The saw carriage: High performance, low consumption

Exceptionally smooth running, high precision and low energy consumption are the hallmarks of the saw carriage developed especially for the SAWTEQ S-500/S-510.



### Saw carriage

- Torsion-resistant, rugged and resilient basic design of the steel plate body for maximum dynamics and precision
- Infinitely variable feed speed – for precision cutting of demanding materials
- Long-term accuracy of saw blade projection
- Fast, precise and infinitely variable positioning of the main saw blade by means of linear guide system with rocker arm
- Motorized lift with electrically driven ball-screw spindle for raising the main saw blade (available as an option for even more speed)
- Equipped as standard with cutting line control: A sensor on the saw carriage monitors the cut and registers even minute deviations of the saw blade. If machine and/or quality specifications are not met, cutting stops immediately: The saw blade is lowered and moved back, and the cut is repeated — at an adjusted speed if necessary.
- All main and scoring saw parameters can be stored. This means that the pair of saw blades can be refitted after sharpening without requiring readjustment (available as option if the scoring saw is motor lifted).
- Low-noise, maintenance-free main saw blade drive unit
- Spring-pressured running rollers (patented) – ensure perfect contact with the guides even after several years of use
- Light sensor with blower unit
- Easy-to-maintain design for minimal belt wear and simplified belt changes
- Innovative dust extraction technologies



### Power-Loc system

Making it quick and easy to change the saw blade.

[MORE AT HOMAG.COM](https://www.homag.com)



Power-Loc

Illustrations may show the technical principle but not the precise machine variant described. Further optional features, for example, may be shown.

## Extremely stable and low levels of vibration thanks to SORB TECH

The SORB TECH saw body of the SAWTEQ S-500 and S-510 is designed for maximum precision despite extreme loads. SORB TECH is a low-vibration and torsion-resistant material that is uniquely stable and available only for saws from HOMAG.



### Saw body made of SORB TECH

The faster a machine operates, the higher the susceptibility to vibration and the noise level become. This is why the SAWTEQ S-500 and S-510 saw body (machine base) is made of SORB TECH. This innovative construction material consists of hard stone grit in various sizes that is combined with bonding agents and special additives to form a casting compound specifically designed for the requirements.

The result: Even after many millions of load changes, the saw body is extremely torsion resistant, stress free, quiet and stable, emitting only low levels of vibration.

- This enables the saw carriage and therefore the saw blades to run in an extremely precise manner
- Less wear and longer service lives – this reduces the operating costs
- Machine table at a comfortable working height
- SAWTEQ S-500 and S-510 models are much quieter than other saws thanks to SORB TECH

### THE BENEFITS OF SORB TECH in comparison to designs with steel supports

**10times** higher vibration damping

**20%** higher sound absorption

**30%** longer service life for saw blades

**40%** less primary energy needed for manufacturing processes

## The SAWTEQ S-510 with lifting table – more technology from the start

Panel dividing saws with integrated lifting table set themselves apart with their automatic feed system and increased level of automation. In short, these saws work differently from the SAWTEQ S-500 without lifting table and therefore require additional technical solutions even in their standard version.



### Powerful feed system

- In the case of lifting table machines, panels are fed via an electro-hydraulic four-column lifting table
- Automatic determination of book height
- Equipped as standard with longitudinal profiles and sensing device
- Also suitable for thin materials from 9.5 mm upward. Suitable for materials from 3 mm upward if equipped with the optional micro feed and hold-back device (page 32)
- Maintenance-free and no lubrication required



### Separate backing wall

- Not attached to the machine base, to ensure precise cutting
- Feed-stacking, aligning and unloading books of panels has no effect on the machine bed

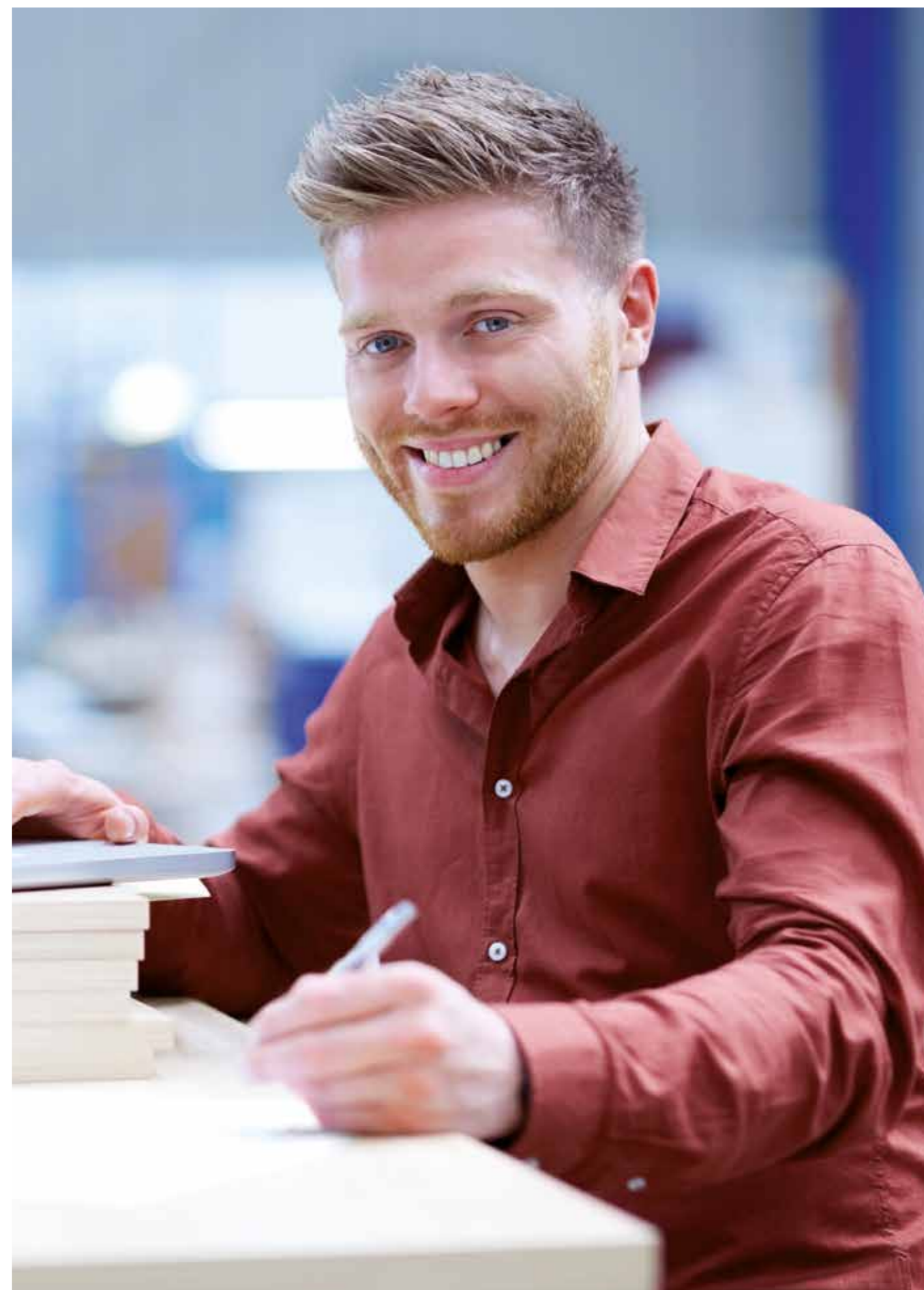

## Optional features

More technology for customized production down to the very last detail: these features allow you to supplement the functionality of your saw in line with your requirements – from adding a link to a storage control connection and performing the actual cutting process to labeling and destacking. So you get exactly the solution you need.



## Feed solutions and storage solutions ranging from S to XXL

Manually transporting panel material from the shelf to the saw is time-consuming and often not ergonomic. This is just one of the reasons why automation solutions from HOMAG pay off within a short time. Furthermore, they save a lot of space and are available for almost every size of company. The spectrum of solutions ranges from the basic feed system via the lifting table through to the large-scale storage control connection to the STORETEQ P-300 and P-500. What's more, all saws in the SAWTEQ S-500 series are also open for connection to virtually all storage systems. This ensures the very highest level of performance.



## Grow together. The universal solution for your warehouse.

Whether it's a wide range of parts, high speeds or full equipment: The new storage range combines the strengths of automation with intelligent logistics. To provide an optimum storage control connection, we have expanded the design of the storage platform for the STORETEQ P-300 and P-500 storage to include a second-level STORETEQ P-310 and P-510 storage system and a STORETEQ P-320 and P-520 dual-level storage system. The storage systems represent intelligent logistics with noticeable optimization effects — above all in the greater reliability, availability and standardized data integration and processing. This is achieved through the consistent use of the leading woodStore storage software.

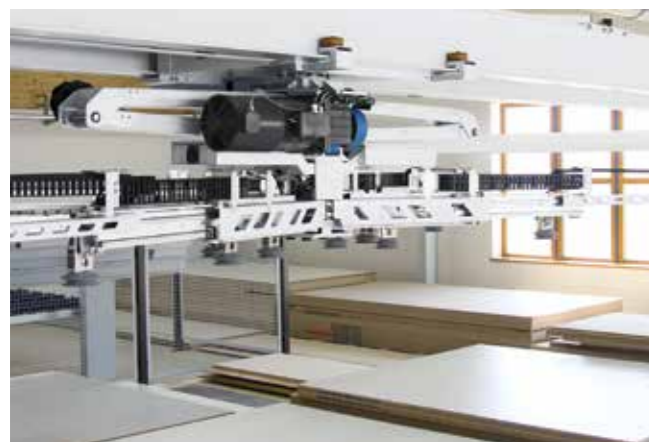

The **ST71 suction cross rail** in X geometry is the ideal optional feature for panel storage. The self-learning cross rail generates the data required for panel handling independently and thus ensures dependable process reliability. The operator does not have to enter anything.

### The HOMAG storage systems optimize your storage area and save valuable production space

- One software solution, all options: The woodStore storage software grows with your requirements
- No compromise: Configure the solution that best suits your requirements
- Intelligent standby – the machine only uses energy when it is actually moving
- Optimal material consumption right down to offcuts thanks to sophisticated material management
- Handling without any extra costs – coated panels from a thickness of 3 mm thanks to the ST 61 suction traverse, which is already included in the standard version
- Perfectly coordinated: Ideal use of the given space – without expensive hall extensions
- A complete solution from a single source – including saw, nesting machine, storage platform and software



### Great variety of materials

Whether it's handling plastic, plexiglass or laminate, coated or uncoated panels, the storage system is also a true all-rounder when it comes to handling panels.

- Panel weights up to **350 kg** and panel lengths up to **5600 mm**
- Smooth transport of even textured surfaces
- High double scissor stability for precise panel handling
- Handling plastic panels



### STORETEQ P-500/P-510/P-520 – flexibility and variety of materials combined in one storage system

The sturdy construction of the STORETEQ P-500/P-510/P-520 allows a great deal of flexibility when designing the system's length and width.

- Span widths of up to **16 m** and travel path lengths of up to **100 m**
- Controlled, low-vibration movements, even in the largest version



## Ten important reasons to opt for the woodStore storage management system

1. Open database systems enables seamless integration
2. Multi Terminal offers transparency and ergonomic operation
3. Smart Connected System: Optimization, processing machine and storage are fully integrated into one cutting system
4. intelliStore: Flexible storage organization that automatically adjusts to production conditions
5. Complete offcut management prevents the buildup of offcuts
6. Forklift operator management: Enables material supply separate from cutting
7. Management of outside storage is integrated
8. Easy Edit production lists: Easy to change orders and sequence
9. Various storage strategies enable easy adjustment to production scenarios
10. Optimization of the production sequence enables high performance

### woodStore 8. Portable, networked, user-friendly.



#### Mobile operation

Various functions can be controlled via mobile end devices connected to the machine's Wi-Fi network.



#### User management

Personnel-controlled storage operation with a functional range of up to 40 different user rights.



#### Smart Connected System

Complete integration of optimization, saw and storage into one cutting system with corresponding standardized interfaces.



#### Email notification

In the event of any malfunctions in the operation of the storage system, the system sends an email to the email account specified.



#### Database access analysis

Customer database is measured for performance and logged to identify digital bottlenecks.



#### Smart Separation Learning

Fully automatic panel separation that requires only two panel handling settings.



#### intelliStore

All storage movements are continuously monitored and automatically adjusted to the current production conditions.



#### Integrated image database

Easy selection and assignment of panel finishes for realistic representation of the panels available in the storage system.



#### Scrap management

Automatic return of saw offcuts to storage with built-in panel measurement as part of the material intake process and management of manual offcut stocks with corresponding wizards for easy setup.



#### woodStore Analyzer

In a period that can be specifically defined, the main functions of the storage system are examined and analyzed according to the customer's requirements in order to determine whether the customer is using the storage system optimally.



## Intelligent logistics are a key to success

HOMAG storage systems are intelligent all-rounders that meet all your needs. From the smallest storage “that would fit into a double garage” to the multi-story storage that would meet industrial requirements. Across all levels of production, the flow of material is optimized, stocks are managed transparently and processing machines are used in an optimal way.

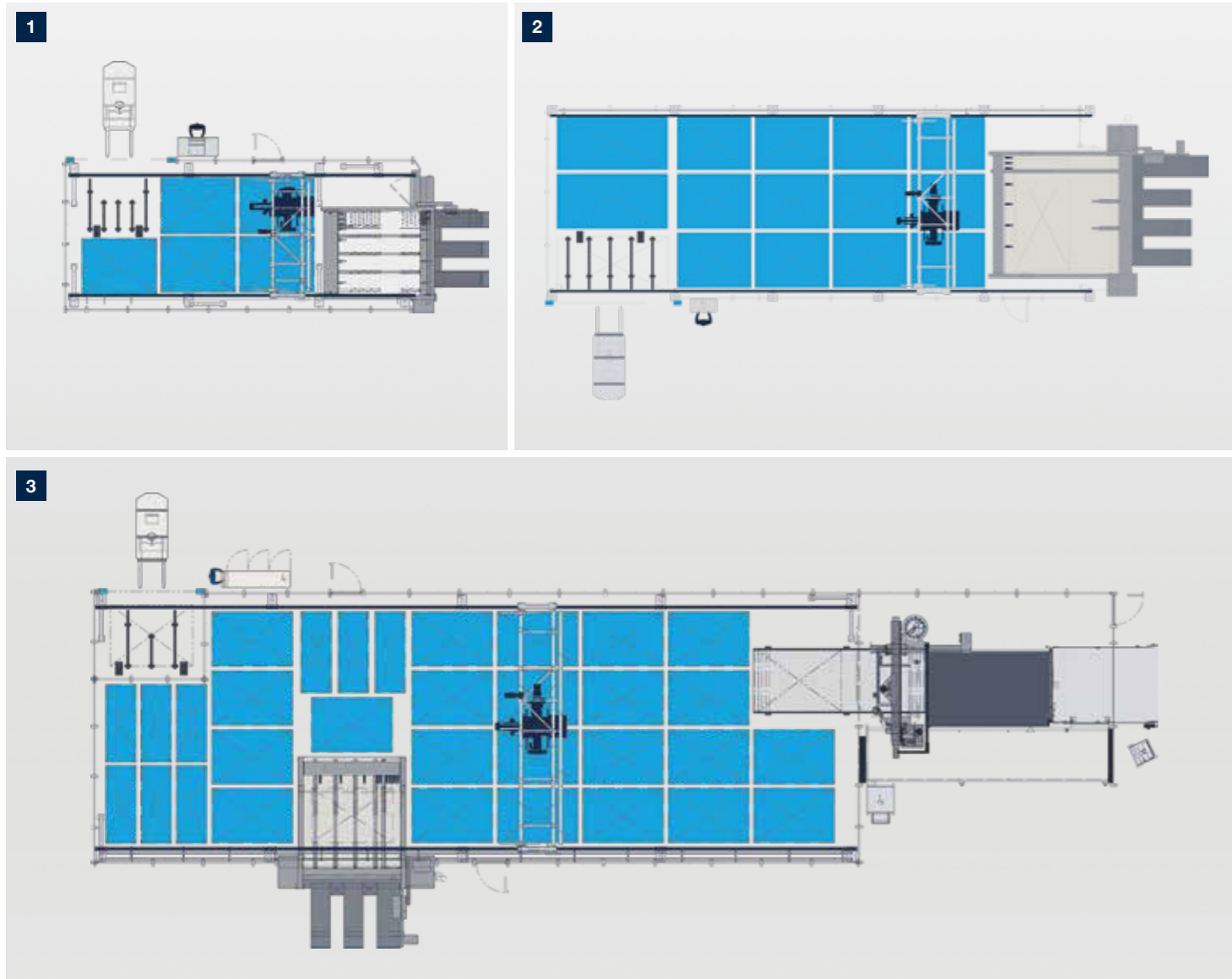

**1 Storage and saw with 5 stacking positions**

Users include those working in traditional joinery

**2 Storage and saw with 14 stacking positions**

Users include fitters

**3 Storage with saw and CNC processing with more than 20 stacking positions**

Users include those working in trade fair and shop construction, suppliers

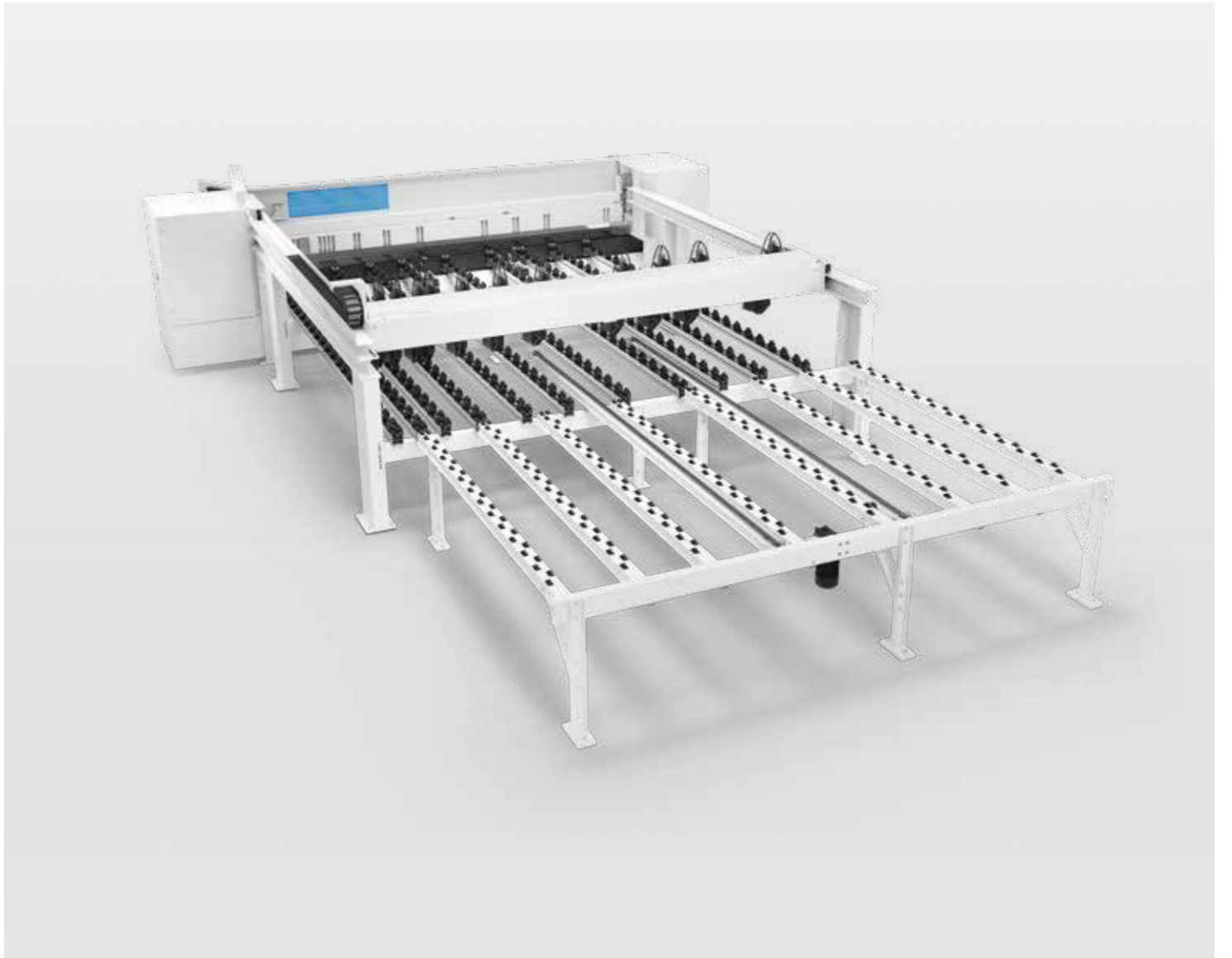

**Feed-stacking table with integrated feed**

When linked to a simple storage control connection, the saw has to stop working briefly when a new panel is fed. The feed-stacking table now ensures smooth, faster cycles: While one panel is still being cut, the storage system already positions the next panel(s) on the feed-stacking table with integrated feed.

- Ideal in combination with the HOMAG panel labeling system (page 38)
- Can be retrofitted at any time
- Plug & Play: Easy add-on
- Perfectly matched to the saw (height, width, roller rails)
- No more waiting times



## High-tech, even on the rear machine table

Exceptional materials require exceptional technical solutions. These are available in abundance for the SAWTEQ S-510 with lifting table – for thin panels, for example.

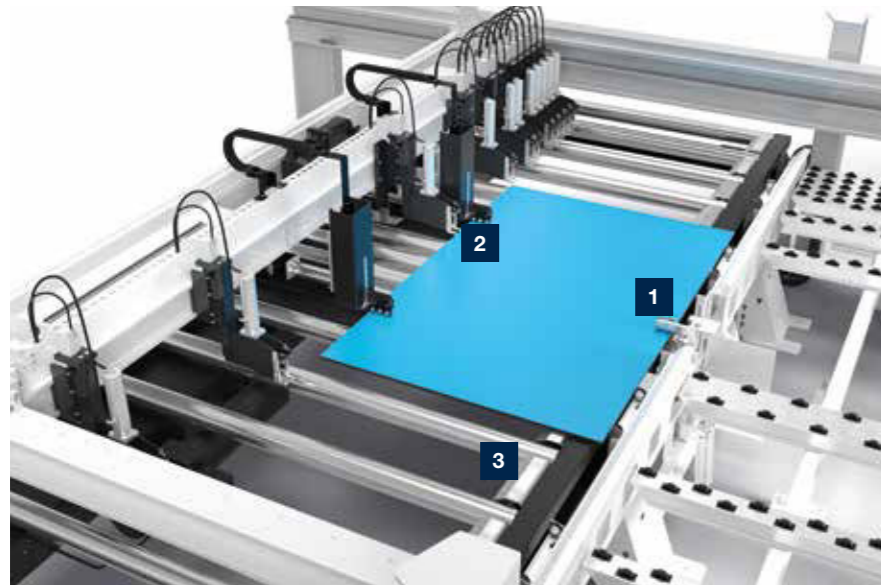

**1 Hold-back device for thin boards**

For thin panels from a thickness of 3 mm.

**2 Micro feed for thin panels**

The micro feed option allows thin panels from 6 mm upward to be pushed onto the rear machine table (provided that their properties meet HOMAG specifications). Book height is measured by a non-contact, electromagnetic measuring system which is completely maintenance-free.

**3 Extra impetus for the feed**

The automatically driven roller conveyor integrated into the lifting table and additional roller conveyors on the side ensure fast stack changeover.

[MORE AT HOMAG.COM](https://www.homag.com)



Micro feed

Illustrations may show the technical principle but not the precise machine variant described. Further optional features, for example, may be shown.



**Automatic ejection guide**

Pushes panel offcuts from the rear machine table across the cutting line to the front and thereby ensures ergonomic and safe working.



**Turning device for headcuts**

- The process is perfectly integrated into the machine cycle, ensuring shorter preparation times and a significant increase in performance.
- Labor-saving device for operators
- With automatic alignment function

[MORE AT HOMAG.COM](https://www.homag.com)



Turning device

## Power Concept speeds up production

At the heart of this technology is a clamp that can be moved separately. Using this clamp, several strips with different cross cut divisions can be cut to length together, significantly increasing material throughput.



**Power Concept Premium:**

- Additional clamp that operates independently
- Clamps on the program fence that can be raised out of the overlapping work area as needed
- Simultaneous processing of two strips of different lengths
- Precision cutting — even of very narrow strips
- An algorithm adapted to the Power Concept Premium sorts the strips directly at the saw. This is based on existing optimization data for the shortest machining times

The Power Concept Premium clamp positions the last strip at the cutting line while the program fence fetches the next panel or the next book of panels from the lifting table. Good to know: To ensure your machine operators can master the considerably faster pace of production with ease, we recommend combining the system with the HOMAG destacking concept (page 10) or with IntelliGuide (page 8).

**POWER CONCEPT**

 **Lower costs per cut**

 **Significantly improved material flow**

 **High material throughput to easily handle peaks in production**

## Small detail, big impact

It is often the smallest details that make the difference. After all, when these details come together, they can have a noticeable impact on the speed and ease of the production process.



### Clamp activation

This option prevents damage to edges. Now also possible: Automatic clamp activation in "measuring" mode.



### Pneumatically operated trim stops

The trim stops are attached to the clamps and are activated as needed by the CADmatic machine control unit.

- Adjustable to common panel thicknesses
- Gentle handling of sensitive materials with overhanging covering layers
- Precise positioning and adjustable to common panel thicknesses

### MORE AT HOMAG.COM



Program-activated clamps



Pneumatically operated trim stops

**Extra-long cutting length**  
SAWTEQ B-500 saws are optionally available with a 5600 mm or 6500 mm cutting length.

**Additional clamps (not shown)**

- For an even better grip on thin, narrow or smooth materials
- For increased material throughput



### Cutting gap closers

Open and close automatically straight after cutting, which prevents narrow strips or trims from becoming caught in the cutting line. They also ensure that the system is readily available.

Each cutting gap closer is individually controlled and monitored to achieve greater reliability (high-level availability)



Cutting gap closers

## Solutions for special cutting tasks

Not only precise, but efficient. Under this banner, HOMAG offers countless optional features for particular cutting tasks. Simply select your solution.

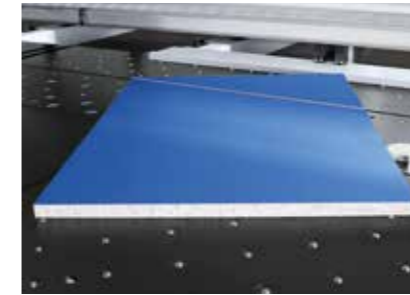

### Manual angle cut

The angle cut device allows you to control angle cuts using the CADmatic control software.

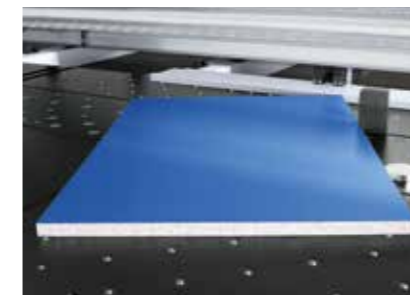

### MORE AT HOMAG.COM



Manual angle cut



### Cut-out and stress elimination cut

Stresses in the material are released when the material is cut and can influence the quality of the dimensions and cuts. The stress elimination cut provides a solution here. Systematic preliminary cuts can be defined during optimization and release the tension in the material. The additional cut-out feature allows you to produce both cut-outs and intermittent grooves in panels, as required for kitchen sinks or doors, for example.

### MORE AT HOMAG.COM



Cut-out function



### MORE AT HOMAG.COM



Grooving



### Grooving and turbo grooving

These options save you an entire work step in post-processing. This is because your saw will also groove the panel material. The turbo grooving option even completes the grooves much faster than a processing center.



Stress-elimination cut

## Air cushions for ergonomic operation

How can your machine operators handle heavy or excessively long parts with ease, even those that are susceptible to scratches? With innovative, tailored machine tables and air cushion tables from HOMAG of course. The choice is yours.



### Movable air cushion table

The air cushion table is easily moved along linear guides and offers you a mobile work surface and storage area. It allows you to move small panels, large panels or books of panels more ergonomically and with less risk of damage.

### Fold-down air cushion table

- Prevents thin materials from sagging
- Increases the work surface
- Primarily for large panels
- Folds down for easy access to the cutting line

### Extended air cushion tables (not shown)

- Extended from 2160 mm to 2810 mm
- Greater freedom of movement
- Better connection to destacking systems
- Very useful when cutting large-format panels

### Wider table elements

Air cushion tables are optionally available in a width of 800 mm instead of 650 mm. Just one, two, three or all four – whatever is best for your production.

[MORE AT HOMAG.COM](https://www.homag.com)



Air cushion tables

Illustrations may show the technical principle but not the precise machine variant described. Further optional features, for example, may be shown.

## dustEx: Making dust a thing of the past!

The more dust and chips that can be taken away by the extraction system, the better. After all, dust and chips can cause scratches on sensitive surfaces.



### Patented dustEx technology

dustEx guides dust and chips on a direct route toward the dust extraction system. How does it work? Using combination air jets and an optimized extraction geometry at the right-angled fence. To complete the dustEx package, we recommend using a dust-trap curtain on either side of the pressure beam.

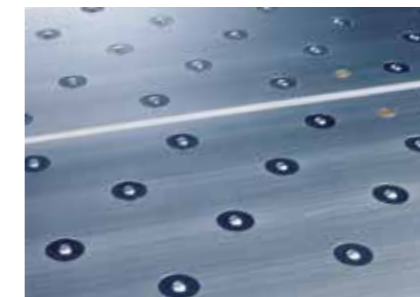

### Dust-trap curtain on both sides

- Attached to the front and rear of the pressure beam. Dust-trap curtain only at the rear when combined with the labeler at the pressure beam
- Protects the operating personnel from dust, improves the suction
- Ideal for dust cuts

### Anodized aluminum machine bed plates

The special coating ensures exceptionally gentle material handling. Ideal for materials with highly sensitive surfaces.

[MORE AT HOMAG.COM](https://www.homag.com)



dustEx

### Light design (not shown)

Consists of the following options:

- LED illumination of the cutting line
- LED illumination of the saw blade change area
- LED illumination in the switch cabinet
- For simple, ergonomic working practices that protect the eyes

## Custom part designation

Whether generated automatically or manually on demand: With labeling solutions from HOMAG, you can clearly label each individual part and ensure parts can be identified at subsequent processing stations.



### Label printer for superb results

The label printer from HOMAG allows you to print customized labels directly at the saw and design them to include bar codes, text and graphics if required. If you also use our Cut Rite optimization software, the material goes directly to the next process step with printed instructions. In this way, you can integrate the saw perfectly into your production flow.



### Panel labeling system

The innovation for saws with automatic storage control connection: the HOMAG panel labeling system labels the unprocessed panel before it is cut — independently of the saw, in non-productive time that previously went unused. It can also be combined with the feed-stacking table with integrated feed (page 31).

- Smallest part size 170 x 170 mm
- Up to 10 labels/min, optionally up to 15 labels/min
- Labeling independent of cutting process
- Saves time, because non-productive time is used productively
- Optimizes handling during destacking because all the parts are already labeled
- Simplifies and speeds up production processes
- Automated parts tracking
- Can be retrofitted
- For smooth processes



### Fully automatic labeling

The labeler is located near the pressure beam, i.e. in your field of vision, and labels the finished parts/books even when several strips are processed simultaneously side by side (Power Concept). It makes no difference whether you feed the panels from the front or the rear. If desired, the position of the label can be individually controlled.

- Guides the operator through precise information on the destacking position or further processing
- Gives precise instructions for further processing
- Saves time

## MORE AT HOMAG.COM



Manual labeling



Panel labeling system



Fully automatic labeling

## Extras for improved efficiency, control and quality

Do you want to produce even more efficiently and monitor production processes with greater ease? You will find the right technology solutions for your cutting application here.



### materialManager Advanced — the advantages at a glance:

- Efficient and simple machine use: Based on your quality requirements and saw blades, your machine automatically adjusts itself correctly to the material — regardless of the respective machine operator.
- Increases performance and ensures quality: Based on the material, predefined machine settings from HOMAG ensure an optimal interaction of feed and saw blade projection, as well as speed where applicable.
- Fewer sources of error: Automatic adjustment of saw parameters when the material is changed. The machine operator is also warned if they are using an unsuitable tool.
- Creates transparency: By looking at the app, the user can easily see how the tool was used and when it needs to be sharpened.
- Up to 8% performance potential: Optimized feed speed at a defined processing quality.
- Up to 20% lower tool costs: Extended tool life thanks to optimal saw parameters.



### Additional start-stop key

- Allows the program sequence to be started independently of the operator control panel
- Equipped with an emergency stop key

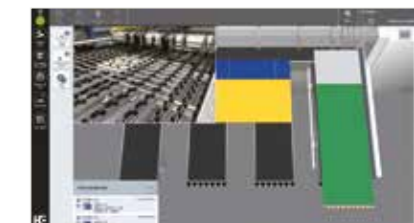

### Everything in view — with video monitoring

- Display of the camera image via the CADmatic control software
- You always have the rear machine table and feed system in view
- Camera pictures can be recorded on request to diagnose errors and for workflow optimization purposes and can be sent to the HOMAG Service department

TECHNICAL DATA*		
Model	SAWTEQ S-500	SAWTEQ S-510
Saw blade projection (mm)	150 (optional: 170)	150 (optional: 170)
Cutting length/width (mm)	3200/3800/4300/5600/6500*****	3200/3800/4300/5600/6500*****
Lifting table width (mm)	-	2200
Program fence speed (m/min)	90**	90**
Saw carriage speed (m/min)	up to 130 (optional 150)	up to 130 (optional 150)
Main saw motor (kW)	50 Hz: 30 (optional 47) 60 Hz: 35 (optional 54)	50 Hz: 30 (optional 47) 60 Hz: 35 (optional 54)
Scoring saw motor (kW)	2.2	2.2
Average total air requirement (NI/min)	240	240
Required compressed air supply (bar)	6	6
Dust extraction system (m³/h)	6000 (7200****), 26 m/sec	6000 (7200****), 26 m/sec
Max. stack height without pit (mm)	-	660 (up to 4300 cutting length) 550 (from 5600 cutting length)
Max. stack weight (t)	-	4
Processing height (mm)	1020	1020
Air cushion tables (mm)	3/3/4/5/6 x 2160	3/3/4/5/6 x 2160

\* Values relate to the standard features

\*\* Forward 25 m/min

\*\*\* Dim. A: incl. 64 mm for suction stubs. Dim. C: Standard program fence width. There are wider dimensions for the lifting table.

\*\*\*\* For the 5600 mm cutting length

\*\*\*\*\* Only available in right-oriented version

\*\*\*\*\* Maximum contact width

Technical data and photographs are not binding in every detail. We reserve the right to make changes in the course of further development.

MACHINE DIMENSIONS***			
S-500 as single saw	A (mm)	B (mm)	C (mm)
S-500 32/32	6235	6693	3660
S-500 38/32	6795	6693	4.220
S-500 38/38	6795	7293	4220
S-500 43/32	7385	6693	4810
S-500 43/38	7385	7293	4810
S-500 43/43	7385	7843	4810
S-500 56/56	8735	9843	6160
S-500 65/65	9735	10,908	7160

MACHINE DIMENSIONS***			
S-510 as single saw with lifting table	A (mm)	B (mm)	C (mm)
S-510 32/16	6235	9318	3660
S-510 38/22	6235	10,078	3660
S-510 38/16	6795	9318	4220
S-510 38/22	6795	10,078	4220
S-510 43/22	7358	10,078	4810
S-510 56/22	8735	11,418	6160
S-510 65/22	9735	12,308	7160

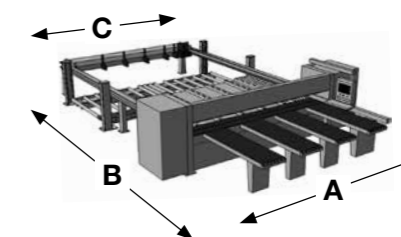
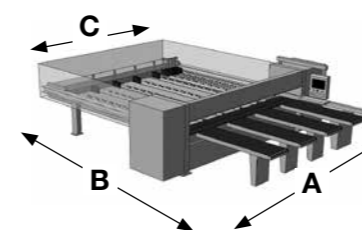

## LIFE CYCLE SERVICES

Improved performance, more efficient processes, faster help, assurance of availability and smarter working.

### TEAM AND SIZE

Largest global service network in the industry with more than 1350 service employees.

### INSTALLATION AND COMMISSIONING

To ensure a really good start, we use only proven experts.

### OPERATION AND CONTROL

After the operating personnel have received expert instruction in the intuitive control system, clever apps help to make the life of the operator much easier.

### SERVICING AND MAINTENANCE

We are happy to take a look to ensure that your machine keeps running. You decide how often and how much help you want from us. Prevention is always better than cure.

### eSHOP AND ONLINE ADVANTAGE

Just a couple of clicks and then it's all systems go. In the available markets, spare parts in particular enjoy exclusive online benefits that are worthwhile. [shop.homag.com](http://shop.homag.com).

### HOTLINE AND AVAILABILITY

In an emergency, we are there for you, via various channels. Directly by phone, digitally via app and video or with on-site service. With more than 90 regional service organizations worldwide, we are always close by. With more than 35,000 spare parts available immediately, we can deliver 85% of your orders straight away.

### TRAINING AND FURTHER EDUCATION

With classroom training, live online training or eLearning, we offer all modern methods for obtaining useful knowledge. We conduct more than 4000 customer training sessions every year. We have our own local training

centers in 19 countries.

### MODERNIZATION AND IMPROVEMENT

Our modernization program is tailored to your machine. We can evaluate your data on request and are happy to advise you on the next step.

### ANALYSIS AND SUSTAINABILITY

On request, we can analyze all of your processes with well-respected tools and procedures (Lean Six Sigma). We have a large team of certified experts for this purpose.

### FINANCING AND CONSULTING

We offer you tailor-made financing concepts worldwide. More than 60 years of experience and a close partner network of renowned banks and insurance companies help us to find the right solution for you. The process is always transparent and reliable.

### Quick help:

94% solution rate via our hotline

### Experts near you:

1350 service employees worldwide

### We get things done:

>1000 spare parts shipments worldwide every day

### Unlike any other:

>150,000 machines electronically documented in 28 languages in eParts



**HOMAG Group AG**

info@homag.com  
www.homag.com

**YOUR SOLUTION**